

POOL A

	GALO Bence	HUN
	BREKKE-JENSSEN Torstein	NOR

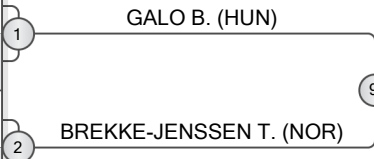

POOL B

	CROCIANI Francesco	ITA
	ISAYEV Askhab	BEL

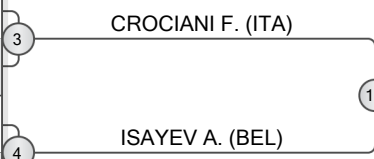

POOL C

	BACHOSHVILI Shota	GEO
	NESIMI Uvejs	KOS
	RATE Mario	ROU

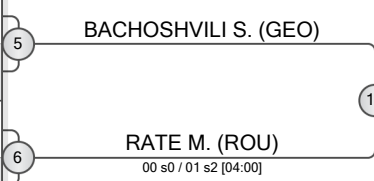

POOL D

	MAMISHOV Nihad	AZE
	DARBINYAN Hayk	ARM

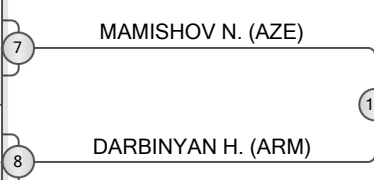

REPECHAGE

13	BREKKE-JENSSEN T. (NOR)
14	CROCIANI F. (ITA)
15	RATE M. (ROU)
16	DARBINYAN H. (ARM)

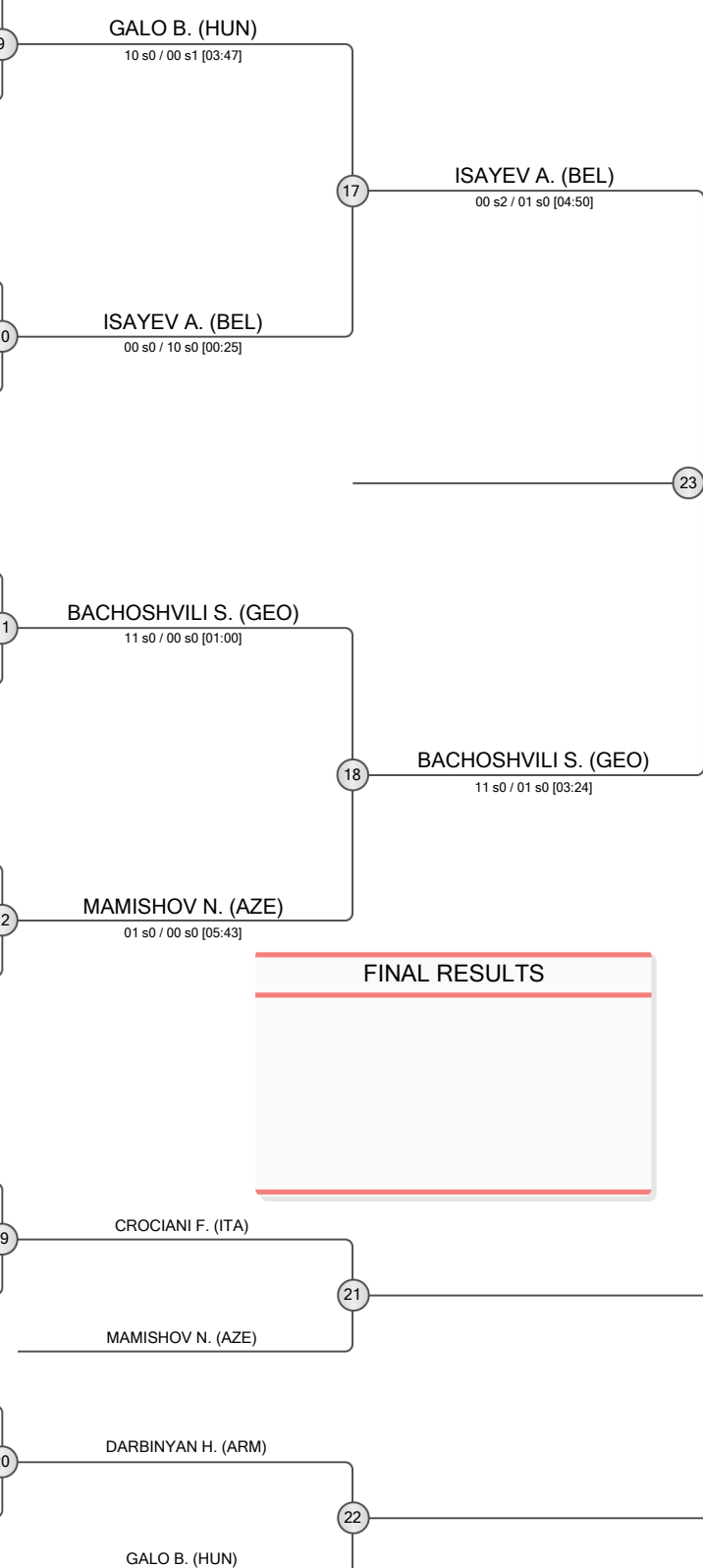
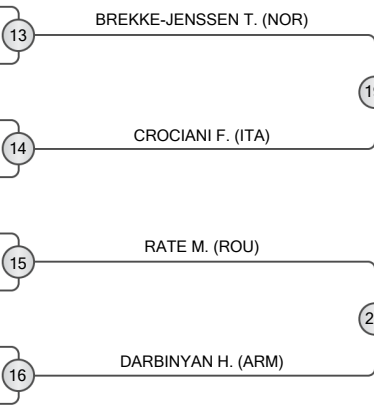

FINAL RESULTS	



# EYOF 2023

Slovenia, Maribor, 25-28 Jul 2023

## -55 kg

Men (16)

### POOL A

	SAMADASHVILI Merabi	GEO
	ANDREYAN Andrey	ARM
	IACOMI Vladimir	MDA
	SOETE Valere	FRA

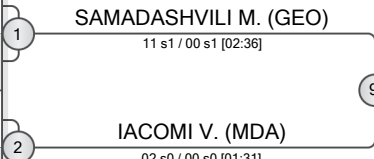

### POOL B

	MIRZAZADA Aykhan	AZE
	POBLOCKI Samir	SWE
	RICHARDSON Luca	NED
	RESHITAJ Andi	KOS

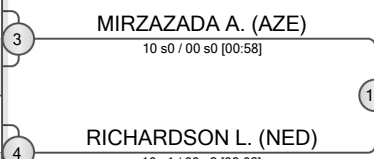

### POOL C

	BLAZIC Gal	SLO
	REICHER Omer	ISR
	LATTANZI Emiliano	ITA
	KOLONDR A Jan	POL

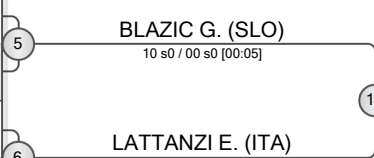

### POOL D

	JORGIC Marko	SRB
	CHRANIUK Jesse	GBR
	LANGE Marcus	DEN
	SHCHEKOTIN Filipp	EST

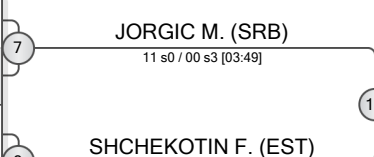

### REPECHAGE

ANDREYAN A. (ARM)	13	IACOMI V. (MDA) 00 s1 / 10 s2 [09:40]
IACOMI V. (MDA)	14	RICHARDSON L. (NED) 00 s0 / 10 s0 [02:15]
POBLOCKI S. (SWE)	15	KOLONDR A J. (POL) 00 s0 / 10 s0 [02:15]
RICHARDSON L. (NED)	16	SHCHEKOTIN F. (EST) 00 s0 / 10 s0 [02:15]
KOLONDR A J. (POL)	17	
BLAZIC G. (SLO)	18	
CHRANIUK J. (GBR)	19	
SHCHEKOTIN F. (EST)	20	

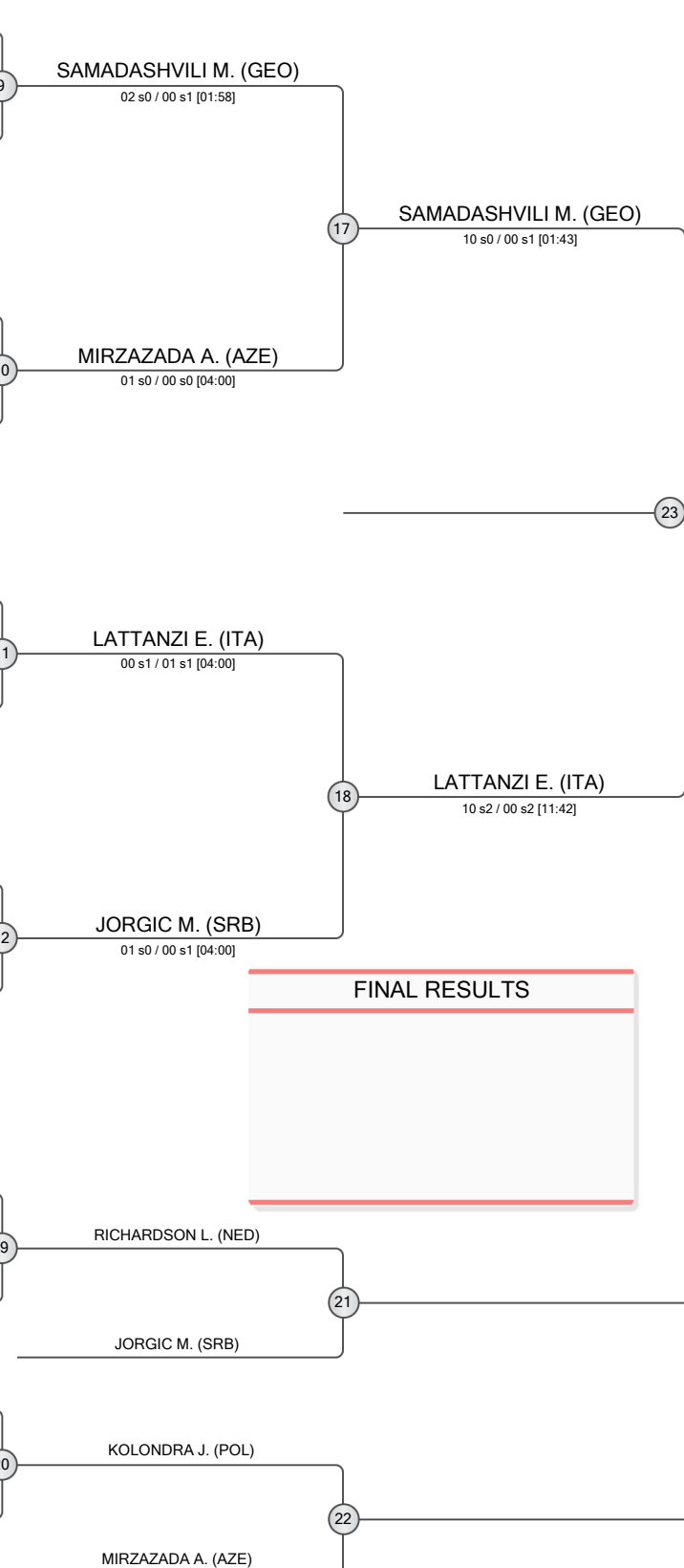

**FINAL RESULTS**

---



# EUROPEAN YOUTH OLYMPIC FESTIVAL



POOL A

TOMANKOVA Patricia SVK

TOMANKOVA P. (SVK)

POOL B

LIMA Imane FRA  
 LARIA Li-Or ISR

LIMA I. (FRA)

10 s0 / 00 s0 [01:05]

POOL C

AUER Nina AUT

AUER N. (AUT)

POOL D

VEILLARD Melody SUI  
 FEUS Anemarie SLO

VEILLARD M. (SUI)

10 s0 / 00 s0 [00:54]

REPECHAGE

LARIA L. (ISR)

LARIA L. (ISR)

FEUS A. (SLO)

FEUS A. (SLO)

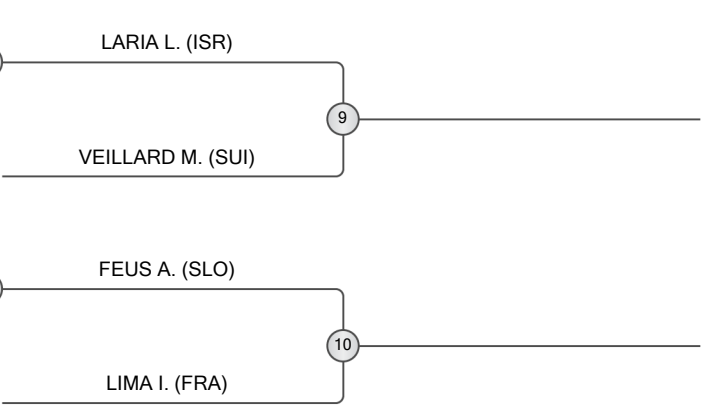
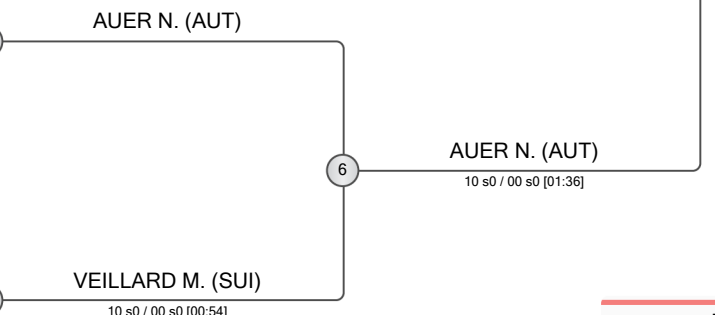
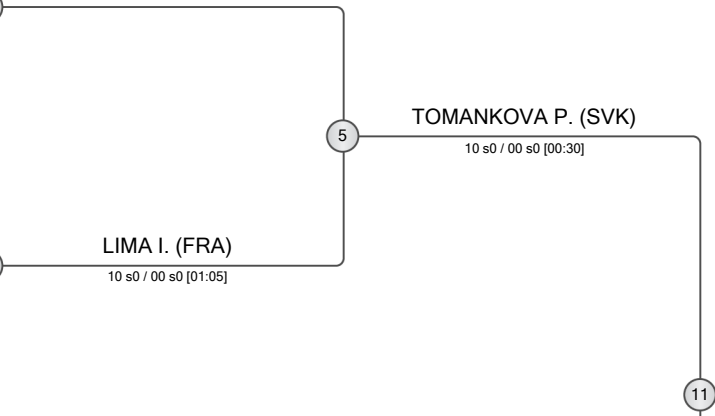

FINAL RESULTS	

